











E-Serie mit Exzenter zur exakten Ausrichtung



 KSF E 140x1600-E76-100 Art.Nr. 26160 - / 15	 KSF E 140x1300-E76-100 Art.Nr. 25502 - / 20	 KSF E 89x1000-E60 Art.Nr. 24300 - / 80	 KSF E 89x800-E60 Art.Nr. 24080 - / 80	 KSF E 89x550-E60 Art.Nr. 24055 - / 130
--	--	---	--	---









F-Serie mit Flanschring oder Rechteck- flanschplatte

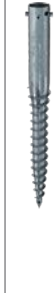

 KSF F 140x1600-P Art.Nr. 25484 - / 20	 KSF F 140x1300-P Art.Nr. 25483 - / 20	 KSF F 76x1600-R Art.Nr. 25478 - / 30	 KSF F 76x1300-R Art.Nr. 25477 - / 30	 KSF F 76x1000-R Art.Nr. 25476 - / 40	 KSF F 76x800-R Art.Nr. 25475 - / 40
--	--	---	---	---	--

G-Serie mit Gewinde- fixierung



 KSF G 114x1300-4xM16 Art.Nr. 24209 - / 30	 KSF G 114x1000-4xM16 Art.Nr. 24208 - / 30	 KSF G 89x1300-4xM12 Art.Nr. 24207 - / 30	 KSF G 89x1000-4xM12 Art.Nr. 24206 - / 30	 KSF G 89x800-4xM12 Art.Nr. 24205 - / 30	 KSF G 76x800-4xM12 Art.Nr. 24201 - / 45	 KSF G 68x650-3xM8 Art.Nr. 21038 8 / 224	 KSF G 68x650-1xM8 Art.Nr. 21037 8 / 224	 KSF G 68x550-1xM8 Art.Nr. 21036 8 / 336
--	--	---	---	--	--	--	--	--









X-Serie Leitpfosten- fundament



 KSF X 135x480-LPS Art.Nr. 22044 6 / 150
--

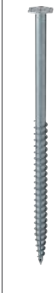
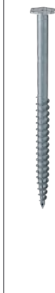



M-Serie mit zentralem Innengewinde



 KSF M 114x2100-M24 Art.Nr. 24223 - / 20	 KSF M 114x1600-M24 Art.Nr. 24222 - / 20	 KSF M 89x2100-M24 Art.Nr. 24219 - / 30	 KSF M 89x1600-M24 Art.Nr. 24218 - / 30	 KSF M 89x1300-M24 Art.Nr. 24217 - / 30	 KSF M 76x2100-M16 Art.Nr. 24215 - / 40	 KSF M 76x1600-M16 Art.Nr. 24214 - / 40	 KSF M 76x1300-M16 Art.Nr. 24213 - / 40	 KSF M 76x1000-M12 Art.Nr. 24212 - / 45	 KSF M 76x800-M12 Art.Nr. 24211 - / 45	 KSF M 76x600-M12 Art.Nr. 24210 - / 45
--	--	---	---	---	---	---	---	---	--	--



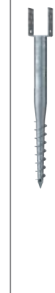
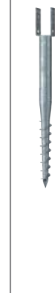



U-Serie zur einfachen Balkenmontage



 KSF U 60x865-111 Art.Nr. 21035 8 / 160/192	 KSF U 60x730-111 Art.Nr. 21033 8 / 192	 KSF U 60x865-91 Art.Nr. 21034 8 / 192/224	 KSF U 60x730-91 Art.Nr. 21032 8 / 192/224	 KSF U 60x730-71 Art.Nr. 21031 8 / 224	 KSF U 60x550-71 Art.Nr. 21030 8 / 224
---	---	--	--	--	--

V76 flexibel verlängerbar für alle Boden- beschaffenheiten









 KSF V 76x3,6 M16 Art.Nr. 25672 - / 120	 KSF V 76x3,6x2000 PT Art.Nr. 25656 - / 100	 KSF V 76x3,6x1500 PT Art.Nr. 25655 - / 120	 KSF V 76x3,6x1500 EH Art.Nr. 25658 - / 50	 KSF V 76x3,6x1500 ET Art.Nr. 25657 - / 40	 KSF V 76x3,6x1500 E Art.Nr. 25659 - / 55	 KSF V 76x3,6x860 E Art.Nr. 25660 - / 150
---	---	---	--	--	---	---

Blau Zahl: Umverpackung / Karton
Rote Zahl: Palettenmenge

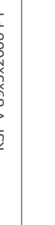
V89 mit hoher Lastenaufnahme- möglichkeit









 KSF V 89x5 M24 Art.Nr. 25771 - / 100	 KSF V 89x5x2000 PT Art.Nr. 25750 - / 60	 KSF V 89x5x1500 PT Art.Nr. 25749 - / 75	 KSF V 89x5x1500 EH Art.Nr. 25770 - / 50	 KSF V 89x5x1500 ET Art.Nr. 25758 - / 75	 KSF V 89x5x1500 E Art.Nr. 25754 - / 100	 KSF V 89x5x860 E Art.Nr. 25751 8 / 150
---	--	--	--	--	--	---

Deutsches
Institut
für
Bautechnik

DIBt



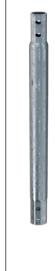

V114 mit hoher Lastenaufnahme- möglichkeit



 KSF V 114x5 M24 Art.Nr. 57822 - / 100	 KSF V 114x5x2000 PT Art.Nr. 25816 - / 15	 KSF V 114x5x1500 PT Art.Nr. 57813 - / 15	 KSF V 114x5x1500 EH Art.Nr. 57821 - / 15	 KSF V 114x5x1500 ET Art.Nr. 25817 - / 20	 KSF V 114x5x1500 E Art.Nr. 57817 - / 25	 KSF V 114x5x860 E Art.Nr. 57816 - / 25
--	---	---	---	---	--	---

V140 mit hoher Lastenaufnahme- möglichkeit







 KSF V 140x6,3 M24 Art.Nr. 57832 - / 50	 KSF V 140x6,3x2000 PT Art.Nr. 57825 - / 30	 KSF V 140x6,3x1500 EH Art.Nr. 57831 - / 25	 KSF V 140x6,3x1500 ET Art.Nr. 57828 - / 30	 KSF V 140x6,3x860 E Art.Nr. 57826 - / 50
---	---	---	---	---

Deutsches
Institut
für
Bautechnik

DIBt

V168 mit hoher Lastenaufnahme- möglichkeit



 KSF V 168x6,3x340 M30 Art.Nr. 25790 - / 36	 KSF V 168x6,3x2000 PT Art.Nr. 25786 - / 8	 KSF V 168x6,3x1500 EH Art.Nr. 25787 - / 8	 KSF V 168x6,3x2000 ET Art.Nr. 25795 - / 8	 KSF V 168x6,3x860 E Art.Nr. 25789 - / 10
---	--	--	--	---

