

KRINNER







E-Serie mit Exzenter zur exakten Ausrichtung



 KSF E 140x3,6x1600-E76-100 TZN Art.Nr. A0382 - / 15	 KSF E 140x3,6x1300-E76-100 TZN Art.Nr. A0380 - / 20
--	--









F-Serie mit Flanschring oder Rechteck- flanschplatte



 KSF F 140x3,6x1600-P TZN Art.Nr. A0387 - / 20	 KSF F 140x3,6x1300-P TZN Art.Nr. A0386 - / 20	 KSF F 76x3,6x1600-R TZN Art.Nr. A0393 - / 30	 KSF F 76x2,6x1300-R TZN Art.Nr. A0389 - / 30	 KSF F 76x2,6x1000-R TZN Art.Nr. A0388 - / 40	 KSF F 76x2,6x800-R TZN Art.Nr. A0390 - / 40
--	--	---	---	---	--

G-Serie mit Gewinde- fixierung

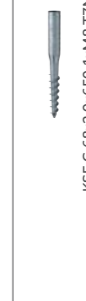

 KSF G 114x3,6x1300 4xM16 TZN Art.Nr. A0401 - / 30	 KSF G 114x3,6x1000 4xM16 TZN Art.Nr. A0400 - / 30	 KSF G 89x2,6x1300 4xM12 TZN Art.Nr. A0413 - / 30	 KSF G 89x2,6x1000 4xM12 TZN Art.Nr. A0412 - / 30	 KSF G 89x2,6x800 4xM12 TZN Art.Nr. A0414 - / 30	 KSF G 76x2,6x800 4xM12 TZN Art.Nr. A0411 - / 45	 KSF G 68x2,0x650 3xM8 TZN Art.Nr. A0406 8 / 224	 KSF G 68x2,0x650 1xM8 TZN Art.Nr. A0405 8 / 224	 KSF G 68x2,0x550 1xM8 TZN Art.Nr. A0403 8 / 336
--	--	---	---	--	--	--	--	--











X-Serie Leitposten- fundament



 KSF X 135x480 LPS TZN Art.Nr. A0517 6 / 150
--







M-Serie mit zentralem Innengewinde



 KSF M 114x3,6x2100 M24 TZN Art.Nr. A0420 - / 20	 KSF M 114x3,6x1600 M24 TZN Art.Nr. A0419 - / 20	 KSF M 89x3,6x2100 M24 TZN Art.Nr. A0455 - / 30	 KSF M 89x3,6x1600 M24 TZN Art.Nr. A0454 - / 30	 KSF M 89x3,6x1300 M24 TZN Art.Nr. A0453 - / 30	 KSF M 76x3,6x2100 M16 TZN Art.Nr. A0447 - / 40	 KSF M 76x3,6x1600 M16 TZN Art.Nr. A0445 - / 40	 KSF M 76x3,6x1300 M16 TZN Art.Nr. A0443 - / 40	 KSF M 76x2,6x1300 M12 TZN Art.Nr. A0435 - / 45	 KSF M 76x2,6x1000 M12 TZN Art.Nr. A0434 - / 45	 KSF M 76x2,6x800 M12 TZN Art.Nr. A0436 - / 45
--	---	---	---	---	---	---	---	---	---	--







U-Serie zur einfachen Balkenmontage

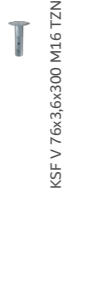

 KSF U 60x2,0x865-111 TZN Art.Nr. A0460 8 / 160/192	 KSF U 60x2,0x730-111 TZN Art.Nr. A0457 8 / 192	 KSF U 60x2,0x865-91 TZN Art.Nr. A0461 8 / 192/224	 KSF U 60x2,0x730-91 TZN Art.Nr. A0459 8 / 192/224	 KSF U 60x2,0x730-71 TZN Art.Nr. A0458 8 / 224	 KSF U 60x2,0x550-71 TZN Art.Nr. A0456 8 / 224
---	---	--	--	--	--

V76 flexibel verlängerbar für alle Boden- beschaffenheiten



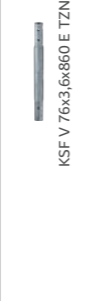





 KSF V 76x3,6x300 M16 TZN Art.Nr. A0502 - / 120	 KSF V 76x3,6x2000 PT TZN Art.Nr. A0500 - / 100	 KSF V 76x3,6x1500 PT TZN Art.Nr. A0499 - / 120	 KSF V 76x3,6x1500 EH TZN Art.Nr. A0497 - / 50	 KSF V 76x3,6x1500 ET TZN Art.Nr. A0498 - / 40	 KSF V 76x3,6x1500 E TZN Art.Nr. A0496 - / 55	 KSF V 76x3,6x860 E TZN Art.Nr. A0503 - / 150
--	--	--	---	---	--	--

Blau Zahl: Umverpackung / Karton
Rote Zahl: Palettenmenge

V89 mit hoher Lastenaufnahme- möglichkeit









 KSF V 89x5,0x300 M24 TZN Art.Nr. A0504 - / 100	 KSF V 89x5,0x2000 PT TZN Art.Nr. A0513 - / 60	 KSF V 89x5,0x1500 PT TZN Art.Nr. A0512 - / 75	 KSF V 89x5,0x1500 EH TZN Art.Nr. A0510 - / 50	 KSF V 89x5,0x1500 ET TZN Art.Nr. A0511 - / 75	 KSF V 89x5,0x1500 E TZN Art.Nr. A0509 - / 100	 KSF V 89x5,0x860 E TZN Art.Nr. A0516 8 / 150
--	---	---	---	---	---	--

Deutsches Institut für Bautechnik
DIBt





V114 mit hoher Lastenaufnahme- möglichkeit



 KSF V 114x5,0x300 M24 TZN Art.Nr. A0475 - / 100	 KSF V 114x5,0x2000 PT TZN Art.Nr. A0472 - / 15	 KSF V 114x5,0x1500 PT TZN Art.Nr. A0471 - / 15	 KSF V 114x5,0x1500 EH TZN Art.Nr. A0468 - / 15	 KSF V 114x5,0x1500 ET TZN Art.Nr. A0469 - / 20	 KSF V 114x5,0x1500 E TZN Art.Nr. A0467 - / 25	 KSF V 114x5,0x860 E TZN Art.Nr. A0477 - / 25
--	---	---	---	---	--	---

V140 mit hoher Lastenaufnahme- möglichkeit







 KSF V 140x6,3x300 M24 TZN Art.Nr. A0479 - / 50	 KSF V 140x6,3x2000 PT TZN Art.Nr. A0486 - / 30	 KSF V 140x6,3x1500 EH TZN Art.Nr. A0484 - / 25	 KSF V 140x6,3x1500 ET TZN Art.Nr. A0485 - / 30	 KSF V 140x6,3x860 E TZN Art.Nr. A0487 - / 50
---	---	---	---	---

Deutsches Institut für Bautechnik
DIBt

V168 mit hoher Lastenaufnahme- möglichkeit



 KSF V 168x6,3x340 M30 TZN Art.Nr. A1354 - / 36	 KSF V 168x6,3x2000 PT TZN Art.Nr. A1353 - / 8	 KSF V 168x6,3x1500 EH TZN Art.Nr. A1351 - / 8	 KSF V 168x6,3x1500 ET TZN Art.Nr. A0490 - / 8	 KSF V 168x6,3x860 E TZN Art.Nr. A1355 - / 10
---	--	--	--	---

PRODUKTÜBERSICHT 2025/2026

KRINNER SCHRAUBFUNDAMENTE

